



# Operator's Manual

## UT-Series

UT-800, UT-1200, UT Spectrum, UT EXTREME HIGH AMBIENT

Revision A

# Introduction

This manual is published for informational purposes only and the information furnished herein should not be considered as all-inclusive or meant to cover all contingencies. If more information is required, consult your Thermo King Service Directory for the location and telephone number of the local dealer.

**Thermo King's warranty shall not apply to any equipment which has been "so installed, maintained, repaired or altered as, in the manufacturer's judgment, to affect its integrity."**

***Manufacturer shall have no liability to any person or entity for any personal injury, property damage or any other direct, indirect, special, or consequential damages whatsoever, arising out of the use of this manual or any information, recommendations or descriptions contained herein. The procedures described herein should only be undertaken by suitably qualified personnel. Failure to implement these procedures correctly may cause damage to the Thermo King unit or other property or personal injury.***

There is nothing complicated about operating and maintaining your Thermo King unit, but a few minutes studying this manual will be time well spent.

Performing pre-trip checks and enroute inspections on a regular basis will minimize operating problems. A regular maintenance program will also help to keep your unit in top operating condition. If factory recommended procedures are followed, you will find that you have purchased the most efficient and dependable temperature control system available.

All service requirements, major and minor, should be handled by a Thermo King dealer for four very important reasons:

- They are equipped with the factory recommended tools to perform all service functions
- They have factory trained and certified technicians
- They have genuine Thermo King replacement parts
- The warranty on your new unit is valid only when the repair and replacement of component parts is performed by an authorized Thermo King dealer

## Machine Information Policy

Use of this product serves as acceptance of the Thermo King Machine Information Policy available at: [www.europe.thermoking.com](http://www.europe.thermoking.com). This product

---

includes a standard feature that collects and shares Machine Information with Thermo King. Separate terms may apply when a customer has entered into an agreement with Thermo King. Customers that would like to opt-out of sharing Machine Information with Thermo King should forward such inquiries to the email address [Opt-Out@ThermoKing.com](mailto:Opt-Out@ThermoKing.com).

## Software License

The product includes software that is licensed under a non-exclusive, non-sublicensable, terminable and limited license to use the software as installed on the product for its intended purpose. Any removal, reproduction, reverse engineering, or other unauthorized use of the software is strictly prohibited. Hacking the product or installing unapproved software may void the warranty. The owner or operator shall not reverse engineer, decompile, or disassemble the software, except and only to the extent that such activity is expressly permitted by applicable law notwithstanding this limitation. The product may include third party software separately licensed as specified in any documentation accompanying the product or in an about screen on a mobile application or website that interfaces with the product.

## Emergency Assistance

Thermo Assistance is a multi-lingual communication tool designed to put you in direct contact with an authorized Thermo King dealer.

**Thermo Assistance should only be contacted for breakdown and repair assistance.**

To use this system, you need the following information before you call: (phone charges will apply)

- Contact Phone Number
- Type of TK Unit
- Thermostat Setting
- Present Load Temperature
- Probable Cause of Fault
- Warranty Details of the Unit
- Payment Details for the Repair

Leave your name and contact number and a Thermo Assistance Operator will call you back. At this point you can give details of the service required and the repair will be organized.

## Introduction

---

Please note that Thermo Assistance cannot guarantee payments and the service is designed for the exclusive use of refrigerated transporters with products manufactured by Thermo King Corporation.



Belgium	+32 270 01 735
Denmark	+45 38 48 76 94
France	+33 171 23 05 03
Germany	+49 695 00 70 740
Italy	+39 02 69 63 32 13
Spain	+34 914 53 34 65
The Netherlands	+31 202 01 51 09
United Kingdom	+44 845 85 01 101
Kazakhstan	+7 7273458096
Russia	+7 4992718539
Others	+32 270 01 735

BEA261

## General Inquires and Unit Maintenance

For general inquiries please contact your local Thermo King dealer.

Go to [www.europe.thermoking.com](http://www.europe.thermoking.com) and select dealer locator for your local Thermo King dealer.

Or refer to the Thermo King Service Directory for contact information.

## Customer Satisfaction Survey

Let your voice be heard!

Your feedback will help improve our manuals. The survey is accessible through any internet-connected device with a web browser.

Scan the Quick Response (QR) code or click or type the web address [https://tranetechnologies.iad1.qualtrics.com/jfe/form/SV\\_2octfSHoUJxsk6x?Q\\_CHL=qr&Q\\_JFE=qdg](https://tranetechnologies.iad1.qualtrics.com/jfe/form/SV_2octfSHoUJxsk6x?Q_CHL=qr&Q_JFE=qdg) to complete the survey.



# Table of Contents

<b>Safety</b> .....	<b>9</b>
Danger, Warning, Caution, and Notice.....	9
General Safety Practices .....	10
Automatic Start/Stop Operation.....	11
Battery Installation and Cable Routing .....	11
Refrigerant.....	13
Refrigerant Oil.....	14
First Aid.....	14
Safety Decals and Locations .....	16
Operation .....	16
Remote Start of the Unit.....	17
Refrigerant .....	17
Do Not Use Ether Starting Aids .....	18
<b>Unit Description</b> .....	<b>19</b>
General Information .....	19
Engine.....	19
Extended Life Coolant (ELC) .....	19
Clutch .....	20
Scroll Compressor .....	20
EMI 3000.....	20
HMI Control Panel .....	20
Standard HMI Control Panel .....	21
Premium HMI Control Panel .....	21
CYCLE-SENTRY™ Start-Stop Controls.....	22
Telematics as Standard .....	22
Further Communication Capabilities.....	22

Defrost .....	23
Engine Compartment .....	24
Unit Protection Devices .....	24
Pharma .....	25
<b>Manual Pretrip Inspection (Before Starting the Unit) .....</b>	<b>27</b>
<b>Operating Instructions .....</b>	<b>30</b>
TSR-3 Controller .....	30
Basic HMI Controller .....	30
Display .....	30
Keys and LED Indicators .....	33
Turning the Unit On and Off .....	36
The Standard Display .....	39
Premium HMI Controller .....	40
<b>Alarm Codes .....</b>	<b>43</b>
Introduction .....	43
<b>Loading and Enroute Inspections .....</b>	<b>44</b>
Inspecting the Load .....	45
Enroute Inspections .....	46
<b>Specifications .....</b>	<b>48</b>
Engine .....	48
Fuses .....	49
Electrical Control System .....	50
Standby Power Requirements .....	51
<b>Warranty .....</b>	<b>52</b>

**Maintenance Inspection Schedule ..... 53**  
    Inspection and Service Intervals ..... 53

**Serial Number Locations ..... 54**

**Recover Refrigerant..... 56**



# Safety

## Danger, Warning, Caution, and Notice

Thermo King® recommends that all service be performed by a Thermo King dealer and to be aware of several general safety practices.

Safety advisories appear throughout this manual as required (refer to examples below). Your personal safety and the proper operation of this unit depend upon the strict observance of these precautions.

### **▲ DANGER**

#### **Example!**

Indicates an imminently hazardous situation which, if not avoided, will result in death or serious injury.

### **▲ WARNING**

#### **Example!**

Indicates a potentially hazardous situation which, if not avoided, could result in death or serious injury.

### **▲ CAUTION**

#### **Example!**

Indicates a potentially hazardous situation which, if not avoided, could result in minor or moderate injury and unsafe practices.

### **NOTICE**

#### **Example!**

Indicates a situation that could result in equipment or property-damage only accidents.

---

## General Safety Practices



### **⚠ DANGER**

#### **Risk of Injury!**

Keep hands and loose clothing clear of fans and belts at all times when the unit is operating with the doors open.

### **⚠ WARNING**

#### **Risk of Injury!**

Do not apply heat to a closed cooling system. Before applying heat to a cooling system, drain it. Then flush it with water and drain the water. Antifreeze contains water and ethylene glycol. The ethylene glycol is flammable and can ignite if the antifreeze is heated enough to boil off the water.

### **⚠ WARNING**

#### **Risk of Injury!**

Temperatures above 120 degrees F (50 degrees C) can cause serious burns. Use an infrared thermometer or other temperature measuring device before touching any potentially hot surfaces.

### **⚠ CAUTION**

#### **Sharp Edges!**

Exposed coil fins can cause lacerations. Service work on the evaporator or condenser coils is best left to a certified Thermo King technician.

## Automatic Start/Stop Operation



### **⚠ CAUTION**

#### **Risk of Injury!**

The unit can start and run automatically any time the unit is turned on. Turn the Microprocessor On/Off switch Off before doing inspections or working on any part of the unit. Please note that only Qualified and Certified personnel should attempt to service your Thermo King unit.

## Battery Installation and Cable Routing



### **⚠ WARNING**

#### **Hazard of Explosion!**

An improperly installed battery could result in a fire, explosion, or injury. A Thermo King approved battery must be installed and properly secured to the battery tray.

### **⚠ WARNING**

#### **Hazard of Explosion!**

Improperly installed battery cables could result in a fire, explosion, or injury. Battery cables must be installed, routed, and secured properly to prevent them from rubbing, chaffing, or making contact with hot, sharp, or rotating components.

**Safety****⚠ WARNING****Fire Hazard!**

Do not attach fuel lines to battery cables or electrical harnesses. This has the potential to cause a fire and could cause serious injury or death.

**⚠ WARNING****Personal Protective Equipment (PPE) Required!**

A battery can be dangerous. A battery contains a flammable gas that can ignite or explode. A battery stores enough electricity to burn you if it discharges quickly. A battery contains battery acid that can burn you. Always wear goggles or safety glasses and personal protective equipment when working with a battery. If you get battery acid on you, immediately flush it with water and get medical attention.

**⚠ WARNING****Hazard of Explosion!**

Always cover battery terminals to prevent them from making contact with metal components during battery installation. Battery terminals grounding against metal could cause the battery to explode.

**⚠ CAUTION****Hazardous Service Procedures!**

Set all unit electrical controls to the OFF position before connecting battery cables to the battery to prevent unit from starting unexpectedly and causing personal injury.

**NOTICE****Equipment Damage!**

Do not connect other manufacturer's equipment or accessories to the unit unless approved by Thermo King. Failure to do so can result in severe damage to equipment and void the warranty.

## Refrigerant



Although fluorocarbon refrigerants are classified as safe, use caution when working with refrigerants or in areas where they are being used.

### **⚠ DANGER**

#### **Hazardous Gases!**

Refrigerant in the presence of an open flame, spark, or electrical short produces toxic gases that are severe respiratory irritants which can cause serious injury or possible death.

### **⚠ DANGER**

#### **Refrigerant Vapor Hazard!**

Do not inhale refrigerant. Use caution when working with refrigerant or a refrigeration system in any confined area with a limited air supply. Refrigerant displaces air and can cause oxygen depletion, resulting in suffocation and possible death.

### **⚠ WARNING**

#### **Personal Protective Equipment (PPE) Required!**

Refrigerant in a liquid state evaporates rapidly when exposed to the atmosphere, freezing anything it contacts. Wear butyl lined gloves and other clothing and eye wear when handling refrigerant to help prevent frostbite.

## Refrigerant Oil



Observe the following precautions when working with or around refrigerant oil:

### **⚠ WARNING**

#### **Personal Protective Equipment (PPE) Required!**

Protect your eyes from contact with refrigerant oil. The oil can cause serious eye injuries. Protect skin and clothing from prolonged or repeated contact with refrigerant oil. To prevent irritation, wash your hands and clothing thoroughly after handling the oil. Rubber gloves are recommended.

## First Aid

### REFRIGERANT

- **Eyes:** For contact with liquid, immediately flush eyes with large amounts of water and get prompt medical attention.
- **Skin:** Flush area with large amounts of warm water. Do not apply heat. Remove contaminated clothing and shoes. Wrap burns with dry, sterile, bulky dressing to protect from infection. Get prompt medical attention. Wash contaminated clothing before reuse.
- **Inhalation:** Move victim to fresh air and use Cardio Pulmonary Resuscitation (CPR) or mouth-to-mouth resuscitation to restore breathing, if necessary. Stay with victim until emergency personnel arrive.
- **Frost Bite:** In the event of frost bite, the objectives of First Aid are to protect the frozen area from further injury, warm the affected area rapidly, and to maintain respiration.

### REFRIGERANT OIL

- **Eyes:** Immediately flush with large amounts of water for at least 15 minutes. Get prompt medical attention.
- **Skin:** Remove contaminated clothing. Wash thoroughly with soap and water. Get medical attention if irritation persists.

- 
- **Inhalation:** Move victim to fresh air and use Cardio Pulmonary Resuscitation (CPR) or mouth-to-mouth resuscitation to restore breathing, if necessary. Stay with victim until emergency personnel arrive.
  - **Ingestion:** Do not induce vomiting. Immediately contact local poison control center or physician.

### **ENGINE COOLANT**

- **Eyes:** Immediately flush with large amounts of water for at least 15 minutes. Get prompt medical attention.
- **Skin:** Remove contaminated clothing. Wash thoroughly with soap and water. Get medical attention if irritation persists.
- **Ingestion:** Do not induce vomiting. Immediately contact local poison control center or physician.

### **BATTERY ACID**

- **Eyes:** Immediately flush with large amounts of water for at least 15 minutes. Get prompt medical attention. Wash skin with soap and water.

### **ELECTRICAL SHOCK**

Take IMMEDIATE action after a person has received an electrical shock. Get quick medical assistance, if possible.

The source of the shock must be quickly stopped, by either shutting off the power or removing the victim. If the power cannot be shut off, the wire should be cut with a non-conductive tool, such as a wood-handle axe or thickly insulated cable cutters. Rescuers should wear insulated gloves and safety glasses, and avoid looking at wires being cut. The ensuing flash can cause burns and blindness.

If the victim must be removed from a live circuit, pull the victim away with a non-conductive material. Use wood, rope, a belt or coat to pull or push the victim away from the current. **DO NOT TOUCH** the victim. You will receive a shock from current flowing through the victim's body. After separating the victim from power source, immediately check for signs of a pulse and respiration. If no pulse is present, start Cardio Pulmonary Resuscitation (CPR). If a pulse is present, respiration might be restored by using mouth-to-mouth resuscitation. Call for emergency medical assistance.

### **ASPHYXIATION**

Move victim to fresh air and use Cardio Pulmonary Resuscitation (CPR) or mouth-to-mouth resuscitation to restore breathing, if necessary. Stay with victim until emergency personnel arrive.

## Safety Decals and Locations

### Operation

The Operation decal is located on your HMI or rear remote controller (if fitted). This decal gives you the information to access/download your unit operator manual and other supporting documentation and in many supported languages.

**Figure 1. Operation Decal**

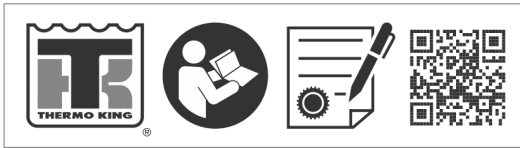

BEN525



## Remote Start of the Unit

### ⚠ CAUTION

#### Risk of Injury!

The unit can start and run automatically any time the unit is turned on. Turn the Microprocessor On/Off switch Off before doing inspections or working on any part of the unit. Please note that only Qualified and Certified personnel should attempt to service your Thermo King unit.

Decals located behind service door.

**Note:** Only present on units fitted with TK TrackKing Telematic's installed.



## Refrigerant

Refrigerant decal located on frame inside door.



BEN501

F Gas decal indicates that this equipment Contains fluorinated greenhouse gases.



SAP1243

## Do Not Use Ether Starting Aids

Figure 2. Do Not Use Ether Starting Aids (Near Engine)



AMA1584

# Unit Description

## General Information

The UT- Series units are one-piece, under-mounted, diesel powered cooling and heating systems designed for straight trucks. The unit uses Chlorine free refrigerant. Remote evaporators are used to control temperatures in up to three individual cargo compartments.

The basic models provide the following:

The UT-Series SPECTRUM™ unit is a microprocessor based transport temperature control system that uses the TSR-3 Truck HMI microcontroller to manage system functions. The unit is a self-powered multi-temperature unit for straight trucks. The condensing unit mounts on the front of the truck cargo compartment. Remote evaporators are used to control temperatures in up to three individual cargo compartments. The unit uses Chlorine free refrigerant.

The basic models provide the following:

- Cooling and hot gas heating on engine operation
- Electric standby operation.

## Engine

Engine power for the UT-Series is a three cylinder, TK376/TK376U, a special clean and quiet diesel engine rated at 18.8 continuous horsepower (14.0 kW) at 2200 RPM, 18.9 continuous horsepower (14.1 kW) at 2250 RPM, and 19.6 continuous horsepower (14.6 kW) at 2425 RPM.

## Extended Life Coolant (ELC)

ELC (Extended Life Coolant) is standard equipment. The maintenance interval for ELC is five years or 12,000 hours. A nameplate on the coolant expansion tank identifies units with ELC. The new engine coolant, Chevron Extended Life Coolant, is RED in color instead of the previous GREEN or BLUE-GREEN colored conventional coolants.

### ***NOTICE***

#### **System Contamination!**

Do not add "GREEN" or "BLUE-GREEN" conventional coolant to cooling systems using "RED" Extended Life Coolant, except in an emergency. If conventional coolant is added to Extended Life Coolant, the coolant must be changed after 2 years instead of 5 years.

## Unit Description

---

**Note:** *The use of 50/50 percent pre-mixed Extended Life Coolant (ELC) is recommended to assure that de-ionized water is being used. If 100 percent full strength concentrate is used, de-ionized or distilled water is recommended over tap water to insure the integrity of the cooling system is maintained.*

## Clutch

The centrifugal clutch engages fully at  $600 \pm 100$  RPM on engine operation, constantly turning the compressor, alternator, and fans at both high and low speed. The clutch isolates the engine from the belt drive system during electric standby operation on Model 50 units.

## Scroll Compressor

### EMI 3000

EMI 3000 is an extended maintenance interval package. It is standard equipment. The EMI 3000 package consists of the following key components:

- EMI 3000-Hour Cyclonic Air Cleaner Assembly and Air Cleaner Element
- EMI 5-Micron 3000-Hour Fuel Filter
- EMI 3000-Hour Dual Element Oil Filter
- API Rating CI-4 Mineral Oil
- Five Year or 12,000 Hour ELC (Extended Life Coolant)

The EMI package allows standard maintenance intervals for air cleaner, air cleaner element, fuel filter and dual element oil filter to be extended to 3,000 hours, or 2 years, whichever occurs first.

**Note:** *Units equipped with the EMI 3000 package do require regular inspection in accordance with Thermo King's maintenance recommendations.*

## HMI Control Panel

The HMI Controller communicates with the Base Controller (located inside the control box) and is used operate the unit and display unit information. It also provides access to all the controller functions and menus.

## Standard HMI Control Panel

The Standard HMI Control Panel (Human/Machine Interface) is used to operate the unit and display unit information. The Control Panel is typically located in the vehicle driver's compartment and communicates with the base controller using a connection on the interface board.

**Figure 3. Standard HMI Control Panel**

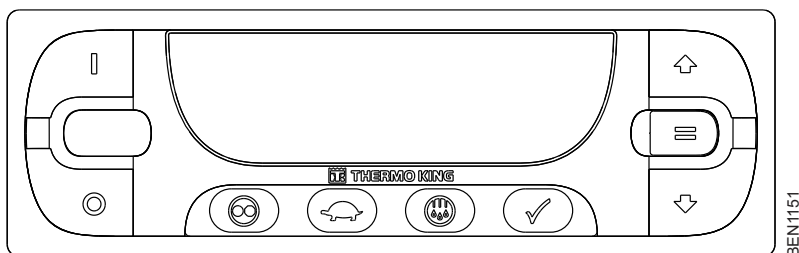

## Premium HMI Control Panel

The Premium Truck HMI (Human/Machine Interface) Control Panel is available as an option on TSR-3 applications. It is used to operate the unit, display unit information and access all TSR-3 Maintenance and Guarded Access Menus. The Control Panel is typically located in the vehicle driver's compartment and communicates with the base controller using a connection on the interface board.

**Figure 4. Premium HMI Control Panel**

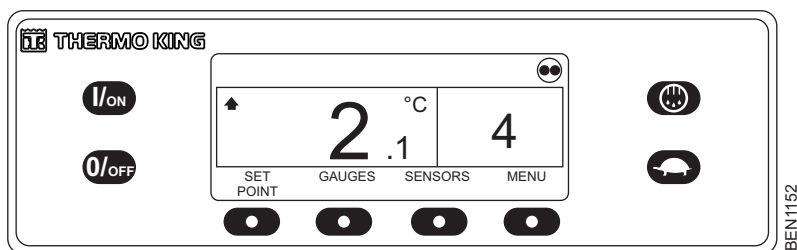

**Figure 5. Premium HMI Control Panel - Spectrum**

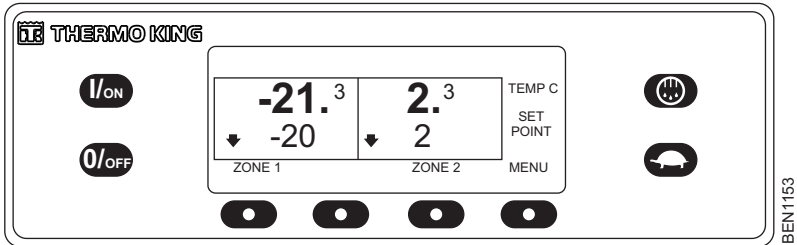

## CYCLE-SENTRY™ Start-Stop Controls

The CYCLE-SENTRY Start-Stop fuel saving system provides optimum operating economy. When CYCLE-SENTRY Mode is selected the unit will start and stop automatically to maintain setpoint, keep the engine warm and the battery charged. When Continuous Mode is selected, the unit starts automatically and runs continuously to maintain setpoint and provide constant airflow.

## Telematics as Standard

**TracKing:** These units come with TracKing communication device and Bluetooth® as standard.

**Note:** *Your unit may not have a standard configuration and therefore may not include this facility. Please contact your Thermo King Dealer for more information.*

You can also download from your App store the appropriate App to connect, and manage your unit from your mobile device. Please contact your Thermo King Representative for more information. Refer to ("[Specifications](#)," p. ) for Specifications.

## Further Communication Capabilities

**Cable connection:** when using a laptop with WinTrac™ software.

**ServiceWatch™:** ServiceWatch is standard equipment. It records operating events, alarm codes, and compartment temperatures as they occur and at preset intervals. This information is typically used to analyze unit performance. Use a USB port to download the ServiceWatch data.

---

**Important:** A ServiceWatch download can be helpful when diagnosing a problem. Therefore, it is recommended that a ServiceWatch download be performed to help diagnose a problem. A ServiceWatch download must be performed before contacting the Thermo King Service Department for assistance in diagnosing a problem.

**CargoWatch™:** CargoWatch data logging requires the installation of optional sensors. Up to six temperature sensor/probes and four door switches can be installed. CargoWatch also logs the setpoint. Use the CargoWatch Port to download the CargoWatch data. If optional temperature sensors are installed, the readings are displayed as Datalogger Sensor (1-6) Temperature in the sensor readings.

**Printer Port:** This port is used to print trip records from the CargoWatch™ datalogger download. It is located inside the control box.

**USB key:** via the USB port provided as standard, eliminating the need for laptops and cables.

**GPRS connection:** via TrackKing™ tool which allows online fleet and temperature management.

**Wireless communication:** As end customers demand increasing temperature traceability, transporters need a simple and effective means of accessing critical data.

## Defrost

Frost gradually builds-up on evaporator coils as a result of normal operation. The unit uses hot refrigerant to defrost the evaporator coil. Hot refrigerant gas passes through the evaporator coil and melts the frost. The water flows through collection drain tubes onto the ground. The methods of defrost initiation are Automatic and Manual.

**Manual Defrost:** In Manual Defrost mode, the operator initiates a defrost cycle.

**Note:** *The unit will not perform a Manual Defrost Cycle unless the unit has been turned on with the ON key, the unit is running in Continuous or CYCLE-SENTRY Mode (or shut down in CYCLE-SENTRY Null Mode), and the coil temperature is below 45°F (7°C)/7°C (45°F).*

---

## Engine Compartment

### ⚠ WARNING

#### Risk of Injury!

The unit can start at any time without warning. Press the OFF key on the HMI control panel and place the microprocessor On/Off switch in the Off position before inspecting or servicing any part of the unit.

### ⚠ CAUTION

#### Service Procedures!

Turn the unit off before attempting to check the engine oil.

The following maintenance items can be checked visually.

**Engine Oil Dipstick:** Use the engine oil dipstick to check the engine oil level.

## Unit Protection Devices

**Coolant Level Switch:** The coolant level switch closes if the coolant level drops below an acceptable level. If it stays closed for a specified time, the microprocessor records Alarm Code 37.

**Engine Coolant Temperature Sensor:** The microprocessor uses the engine coolant temperature sensor to monitor the engine coolant temperature. If the engine coolant temperature rises above an acceptable level, the microprocessor records Alarm Code 41 and possibly 18. The microprocessor might also shut the unit down.

**High Pressure Cutout Switch:** The high pressure cutout switch is located on the compressor discharge manifold. If the compressor discharge pressure becomes excessive, the switch opens the circuit to the run relay to stop the unit. The microprocessor will record Alarm Code 10.

**High Pressure Relief Valve:** This valve is designed to relieve excessive pressure in the refrigeration system. It is located on the receiver tank. If the high pressure relief valve opens, much of the refrigerant will be lost. Take the unit to a Thermo King dealer if this occurs.

**Low Oil Level Switch:** The low oil level switch closes if the oil drops below an acceptable level. If it stays closed for a specified time, the microprocessor shuts the unit down and records Alarm Code 66.

**Low Oil Pressure Switch:** The low oil pressure switch closes if the oil pressure drops below an acceptable level. If it stays closed for a specified time, the microprocessor shuts the unit down and records Alarm Code 19.



**Preheat Buzzer:** The preheat buzzer sounds when the controller energizes the preheat relay. This warns anyone near the unit that the controller is about to start the engine.

**Overload Relay - Automatic Reset :** An overload relay protects the standby electric motor. The overload relay opens the circuit to the electric motor if the motor overloads for any reason (e.g., low line voltage or improper power supply) while the unit is on electric standby operation. The microprocessor will record Alarm Code 90.

**Smart FETs:** Smart FETs in the base controller protect some circuits and components from an overcurrent condition.

**Fuses:** A number of fuses, located on the base controller, protect various circuits and components. The base controller is located inside the control box.

## Pharma

Single temperature units qualified for pharmaceutical applications under Thermo King protocol are configured with specific Optiset profiles visible on the HMI display as follow:

- PHARMA AMBIENT: for temperature ranges +15°C to 25°C
- PHARMA CHILLED: for temperature ranges +2°C to 8°C
- PHARMA FROZEN: for temperature below -20°C

In case the operator is not using the Optiset profiles, ThermoKing recommends to run the unit with the recommended Setpoints below:

**Table 1. 45 feet container with Thermo King UT-1200**

<b>Temperature Range</b>	<b>Extreme Ambient Temperature</b>	<b>Recommended Setpoint</b>	<b>Max Deviation from Setpoint</b>
Temperature < -20° C	+45°C / -30°	-25°C	+1/- 3°C of setpoint
Temperature between 2°C and 8° C	+45°C / -30°	+5°C	+2/- 2°C of setpoint
Temperature between 15°C and 25°C	+45°C / -30°	+20°C	+2/- 1°C of setpoint

For multi-temperatures units qualified for pharmaceutical applications under ThermoKing protocol, ThermoKing recommends to operate the unit with:

## Unit Description

---

- PTC parameter ACTIVATED (ON)
- Zone 1 DAC Kit switch turned ON with the recommended Setpoints below:

**Table 2. Truck body with Thermo King UT-1200 Spectrum unit**

<b>Temperature Range</b>	<b>Extreme Ambient Temperature</b>	<b>Recommended Setpoint</b>	<b>Max Deviation from Setpoint</b>
Temperature between 2°C and 8°C	+40°C / -30°	+5°C	+/- 3°C of setpoint
Temperature between 15°C and 25°C	+40°C / -30°	+20°C	+2/- 3°C of setpoint

# Manual Pretrip Inspection (Before Starting the Unit)

Pretrip inspections are an important part of a preventative maintenance program designed to minimize operating problems and breakdowns. Perform this pretrip inspection before every trip involving refrigerated cargo.

**Notes:**

1. Refer to ("*Loading and Enroute Inspections*," p. 44) also before commencing your journey.
2. Pretrip inspections are not intended to take the place of regular maintenance inspections.

**Fuel:** Verify the diesel fuel supply is adequate to guarantee engine operation to the next check point. Allow for maximum fuel consumption of per hour of engine operation.

## ⚠ CAUTION

### Service Procedures!

Turn the unit off before attempting to check the engine oil.

**Engine Oil:** Check the engine oil level. It should be at the Full mark when the dipstick is threaded all the way into the oil pan. Do not overfill.

## ⚠ CAUTION

### Hazardous Pressures!

Do not remove expansion tank cap while coolant is hot.

**Engine Coolant:** The engine coolant must have antifreeze protection to -34 C (-30 F). Add coolant if Alarm Code 37 is active. Check and add coolant to the expansion tank.

**Note:** Refer to Specifications ("*Specifications*," p. 48) where it is clearly states which coolant types are allowed to be used in this unit.

**Battery:** Verify the battery terminals are tight and free of corrosion.

## Manual Pretrip Inspection (Before Starting the Unit)

---

**Note:** *All truck and trailer units will have a small battery drain when the unit is off. The battery can be drained even quicker if there are Aftermarket options or third party devices connected to the unit which consume battery power.*

*This will cause the battery to become discharged over time.*

*Apart from the obvious inconvenience of having to charge the battery, it is also liable to damage battery cell material and cause the life of the battery to be shorter than acceptable.*

*Therefore, to ensure the battery remains in optimum condition during periods when the unit is not being used, Thermo King strongly recommends to switch on the unit at least once each week and run for 30 minutes or longer.*

*If the EnergyONE battery is drained after a long idle period, it will need to be recharged using an automatic programmable battery charger (Thermo King does not recommend the use of manual battery chargers on dry cell batteries).*

*Failure to do so may result in warranty for the battery being rejected.*

*Alternatively, Thermo King offer a solar panel option from aftermarket which would negate the requirement to switch off the microprocessor switch during long unit idle periods. For more information, please contact your local Thermo King dealership.*

**Belts:** Verify belts are in good condition and adjusted to the proper tension. For more information about belt tension, see the Specifications chapter.

**Electrical:** Check the electrical connections to verify they are securely fastened. Wires and terminals should be free of corrosion, cracks, and moisture.

**Structural:** Visually inspect the unit for leaks, loose or broken parts, and other damage.

**Coils:** Verify condenser and evaporator coils are clean and free of debris.

- Washing with clean water should be sufficient.
- The use of cleaning agents or detergents is strongly discouraged due to the possibility of degradation of the construction.
- If using a power washer, the nozzle pressure should not exceed 600 psi (41 bar). For the best results, spray the coil perpendicular to the face of the coil. The spray nozzle should be kept between 1 inch and 3 inches (25 to 75 millimeters) from the coil surface.
- If necessary to use a chemical cleaner or detergent, use a cleaner that does not contain any hydrofluoric acids and is between 7 and 8 on the pH

## Manual Pretrip Inspection (Before Starting the Unit)

---

scale. Verify dilution instructions provided by the detergent supplier are followed. In case of doubt about the compatibility of the detergent with the type of materials listed above, always ask the supplier a written confirmation of the compatibility.

- Should a chemical cleaner be required, it is **MANDATORY** that all components are thoroughly rinsed with water even if the instructions of the cleaner specify that it is a “no rinse” cleaner.

### **NOTICE**

#### **Equipment Damage!**

Failure to comply with above mentioned guidelines will lead to a shortened life of the equipment to an indeterminable degree and also may void your warranty.

**Note:** *The repeated transportation of meat and fish waste can cause extensive corrosion to the evaporator coils and evaporator section tubing over time due to ammonia formation and can reduce the lifespan of the coils. Appropriate additional measures should be taken to protect the coils against the aggressive corrosion that can result from transportation of such products.*

**Cargo Box:** Check the interior and exterior of the cargo box for damage. Any damage to the walls or insulation must be repaired.

**Cargo Doors:** Verify the cargo doors and weather seals are in good condition. The doors should latch securely and the weather seals should fit tightly.

**Defrost Drains:** Check the defrost drain hoses to verify they are open.

**Remote Evaporators:** UT-1200 SPECTRUM)

- Visually inspect Evaporator(s) for damaged, loose, or broken parts.
- Check also for refrigerant leaks.
- Check Defrost initiation and termination (including defrost timer) by activating/initiating a manual defrost.

**Tracking Module:**

- Check that the module is turned on and communicating.

# Operating Instructions

## TSR-3 Controller

Refer to “Profesor Kool” and the “TK Tutor Series” for step by step instructions and training on how to use your Standard or Premium HMI and also “TK Alarm Codes” to help diagnose any alarms. These can be found at the following link: <http://www.europe.thermoking.com/tools/>

**Note:** *These are App's for your Mobile device, contact your Dealer for desktop applications.*

## Basic HMI Controller

The Basic HMI Controller (Human/Machine Interface) is used to operate the unit and display unit information. The Control Panel is typically located in the vehicle driver's compartment and communicates with the base controller using a connection on the interface board.

**Figure 6. Basic HMI Controller**



SAP357

Please refer to Profesor Kool and the “TK Tutor Series” for step by step instructions and training on how to operate your controller and also “TK Alarm Codes” to help diagnose any alarms. These can be found at the following link: <http://www.europe.thermoking.com/tools/>

**Note:** *These are Apps for your Mobile device, please contact your Dealer for desktop applications.*

## Display

The Truck Standard Display consists of a display and nine touch-sensitive keys. The display presents information to the operator and includes setpoint and box temperature, hourmeter readings, alarms, and several icons.

The display is capable of showing numbers and illuminating several icons. It does not display text, making it suitable for use with any language.

The upper row of numbers can display the box temperature, engine run time hourmeter, current zone, or alarm code(s). The lower row of numbers can display the setpoint, electric run time hourmeter, or total number of alarms.

**Figure 7. Control Panel Display**

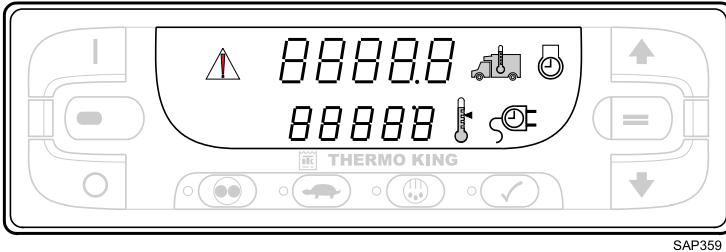

## Display Icons

Display symbols or icons are used to present additional unit information.



When this icon is present in the upper display, it is showing the actual box temperature inside the truck box.



When this icon is present in the lower display, it is showing the current setpoint.



When this icon is present in the upper display, it is showing the diesel engine run time.

## Operating Instructions

---



When this icon is present in the the lower display, it is showing the electric motor run time (if the unit is equipped with optional Electric Standby).



When this Alarm Icon is present, one or more alarm conditions have occurred. If the display is not flashing, any alarms are Check Alarms. If the display is flashing on and off, a Shutdown Alarm has occurred and the unit has been shut down. Immediate action must be taken.



## Keys and LED Indicators

There are nine touch sensitive keys. Some of these keys have more than one function.

**Figure 8. Keys and LED Indicators**

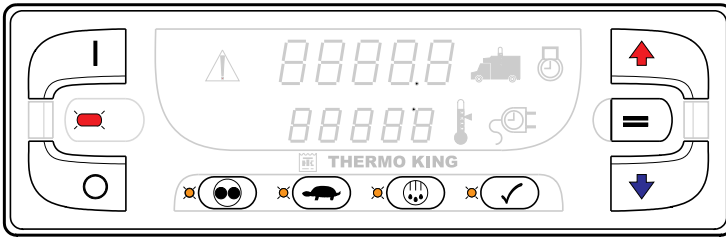

SAP365

There are amber LED indicators located next to each of the four function keys below the display. The LED will glow amber when that function is active. A red LED indicator is located between the ON Key and OFF Key at the left side of the display. This indicator will glow if Alarm Code 91 Check Electric Ready Input occurs. It will also illuminate if a 15 pin Thermo King Data Cable is connected to the serial port on the back of the Base Controller.

ON

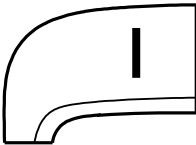

Primary Use – Pressing the ON Key will turn the unit on.

Secondary Use – When the unit is on, pressing this key and the PRETRIP Key at the same time will display any alarm codes that are present.

Secondary Use – When the unit is on, pressing and holding this key allows the UP ARROW Key and DOWN ARROW Key to increase or decrease the display brightness.

Secondary Use – When the unit is on and a different display is shown, pressing this key will return to the Standard Display of box temperature and setpoint.

Multi-Temp Use – When Manual Zone Selection is active the selected zone can be turned on and off by simultaneously pressing the ON Key and ENTER Key.

OFF

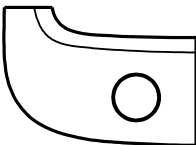

Primary Use – Pressing the OFF Key will turn the unit off.

## Operating Instructions

---

### UP ARROW

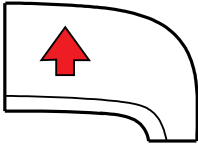

Primary Use – When the unit is turned on and the Standard Display is shown, pressing the UP ARROW Key will increase the setpoint.

Secondary Use – When alarms are being displayed, pressing this key will scroll through the alarms (if more than one alarm is present).

Secondary Use – While holding ON Key down with the unit turned on, pressing this key will increase the display brightness (Low, Medium, High).

### DOWN ARROW

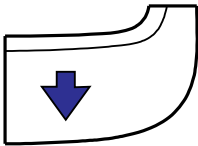

Primary Use – When the unit is turned on and the Standard Display is shown, pressing the DOWN ARROW Key will decrease the setpoint.

Secondary Use – While holding ON Key down with the unit turned on, pressing this key will decrease the display brightness (High, Medium, Low).

### ENTER

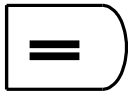

Primary Use – If the setpoint has been changed using the UP ARROW Key and/or DOWN ARROW Key, pressing the ENTER Key enters the setpoint into the base controller's memory.

Secondary Use – When alarms are being displayed, pressing this key will clear the alarm shown on the display.

Secondary Use – When the unit is turned on, press and hold this key for five seconds to send a Start of Trip (SOT) to the data logger.

Multi-Temp Use – Pressing this key will enable Manual Zone Selection mode and scroll through the installed zones, one zone at a time. When a zone is manually selected the zone can be turned on or off, the setpoint can be changed and a manual defrost cycle can be initiated if zone conditions permit.

### CYCLE-SENTRY/CONTINUOUS



Primary Use – If the unit is turned on and is in Continuous Mode, pressing the CYCLE SENTRY/CONTINUOUS Key will switch operation to CYCLE SENTRY Mode and the amber LED indicator will glow. If the unit is running in CYCLE SENTRY Mode, pressing this key will switch operation to Continuous Mode and the amber LED will turn off.

## HIGH SPEED LOCK-OUT



**Primary Use** – If the unit is turned on, pressing the HIGH SPEED LOCKOUT Key will activate High Speed Lock-Out. The unit will switch to low speed operation and the amber LED indicator will glow. No further high speed operation is allowed until this feature is turned off. If the High Speed Lockout Timer is enabled, the unit will automatically return to high speed after a programmed time limit. This feature is typically used in noise sensitive areas to reduce unit noise.

**Note:** *The HIGH SPEED LOCK-OUT Key is only used when the unit is operating in Diesel Mode. The HIGH SPEED LOCK-OUT Key does not have any effect in Electric Mode operation.*

## DEFROST



**Primary Use** – If the unit is turned on, pressing the DEFROST Key will initiate a manual defrost cycle if conditions allow. If the evaporator coil temperature less than 45°F (7°C) the unit will enter a defrost cycle. The amber LED will flash while the defrost cycle is initialized and will glow during the defrost cycle. The defrost cycle will terminate automatically and the amber LED will turn off when the evaporator coil temperature is greater than 52°F (11°C). To manually terminate a defrost cycle turn the unit off and back on.

**Multi-Temp Use** – A zone must be selected before initiating a manual defrost cycle.

**PRETRIP TEST**

Primary Use – Pressing and holding the PRETRIP TEST Key for five seconds will initiate either a Full Pretrip Test or Engine Running Pretrip Test so long as no alarm conditions exist. If the Alarm Icon is glowing, record and clear the alarms before starting the Pretrip Test.

Press and hold the PRETRIP TEST Key for five seconds. The amber LED may flash while the Pretrip Test is initialized and will glow steady while the Pretrip Test is running. When the Pretrip Test is complete the amber LED will turn off.

- If there are no alarm codes set when the Pretrip Test is complete, the unit passed.
- If there are alarm codes set when the Pretrip Test is complete, the unit failed. Check and correct the alarm conditions and repeat the test.
- If a shutdown alarm occurred, Alarm Code 28 Pretrip Abort will be set and the unit will be shut down. Check and correct the alarm conditions and repeat the test.

Secondary Use – When the unit is turned off press and hold this key for five seconds to show the HMI Control Panel Serial Number (in the upper display) and the HMI Control Panel Software Revision (in the lower display).

Secondary Use – When the unit is turned off this key is used to display the Clock/Calendar.

## Turning the Unit On and Off

**Important:** *Verify the Base Controller On/Off Switch is turned on before turning on the HMI Control Panel. The Base Controller On/Off switch is located on the outside of the control box side of the unit.*

If the HMI Control Panel is turned on and the Base Controller On/Off Switch is turned off, the HMI display screen will flash on and off.

The unit is turned on by pressing the ON Key and off by pressing the OFF Key. When the ON Key is pressed, the display briefly shows dashes as the display initializes.

**Important:** *If the display flashes on and off continuously when the ON Key is pressed, check to verify the Base Controller On/Off switch is in the ON position.*

**Figure 9. Keys and LED Indicators**

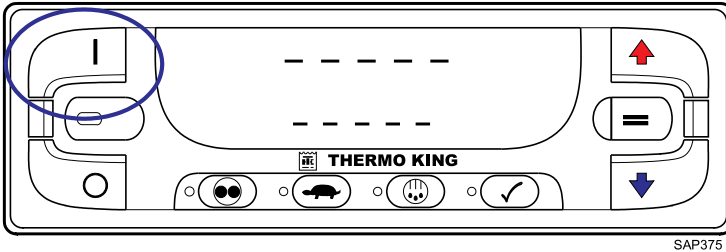

The unit running time hourmeters are shown for 30 seconds. The diesel engine run time hours and Diesel Icon are shown in the upper display. If the optional Electric Standby Feature is installed, the electric motor run time hours and Electric Icon appear in the lower display as shown (Figure 10, p. 37).

A Full Pretrip Test is initiated from this display by pressing and holding the Pretrip Key as shown later in this section.

**Figure 10. Electric Motor Run Time Hours and Electric Icon**

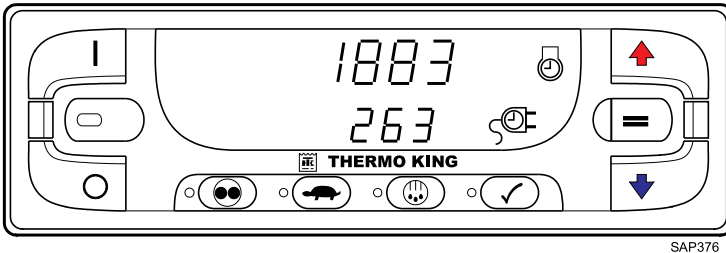

When the unit is ready to run, the Standard Display of box temperature and setpoint appears. The box temperature and Box Temp Icon are shown in the upper display. The setpoint and Setpoint Icon are shown in the lower display. The box temperature shown (Figure 11, p. 38) is 35.8°F (2.1°C) with a 35°F (1.6°C) setpoint.

# THERMO KING

## Operating Instructions

Figure 11. Standard Display of Box temperature and Setpoint

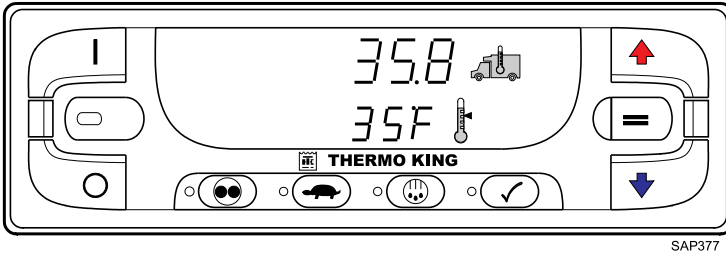

When the unit is ready to run, the Standard Display of box temperature and setpoint appears. The box temperature and Box Temp Icon are shown in the upper display. The setpoint and Setpoint Icon are shown in the lower display. On multi-temperature applications, the Zone indicators are shown to the left of the box temperature. In the example (Figure 12, p. 38), Zone 2 is being shown on the display.. The Zone 2 box temperature shown here is 35.8°F (2.1°C) with a 35°F (1.7°C) setpoint.

Figure 12. Zone 2

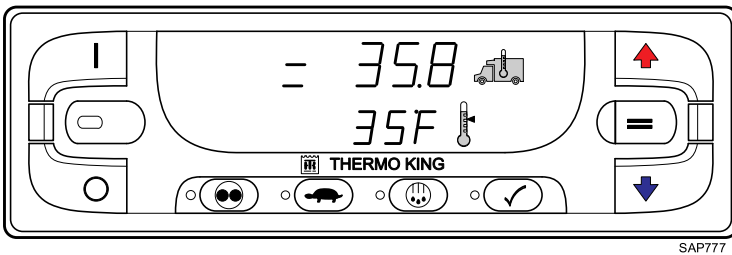

Pressing the OFF Key stops unit operation. The unit shuts down immediately and the display goes blank. To start the unit again, press the ON Key (Figure 13, p. 39).

**Figure 13. ON Key**

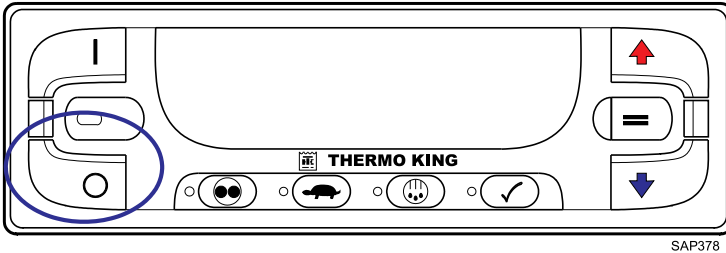

## The Standard Display

The Standard Display is the default display that appears if no other display function is selected. The Standard Display shows the box temperature and setpoint. The box temperature is that measured by the return air sensor. The box temperature and Box Temperature Icon are shown in the upper display. The setpoint and Setpoint Icon are shown in the lower display. The box temperature shown (Figure 14, p. 39) is 35.8°F (2.1°C) with a 35°F (1.6°C) setpoint.

**Note:** If another display is shown, pressing the ON Key will return the display to the Standard Display.

**Figure 14. Standard Display**

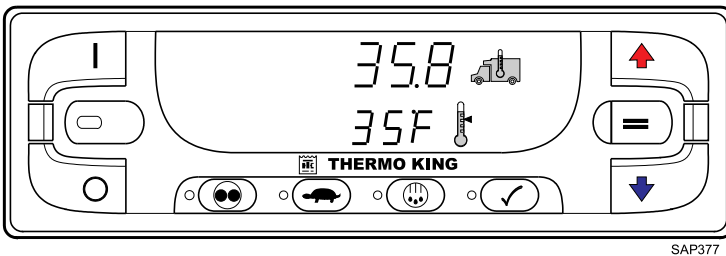

**Premium HMI Controller**

The Premium Truck HMI (Human/Machine Interface) Control Panel is available as an option on TSR-3 Truck applications. It is used to operate the unit, display unit information and access all TSR-3 Maintenance and Guarded Access Menus. The Premium HMI Control Panel communicates with the base controller via the CAN (Controller Area Network) bus. It is connected to the base controller via CAN Connector J14 on the interface board. The Premium HMI Control Panel is typically located in the vehicle driver's compartment. It may be installed in the truck instrument panel using a DIN mounting ring or under the instrument panel using an under dash mounting kit.

Please refer to Professor Kool and the "TK Tutor Series" for step by step instructions and training on how to operate your controller and also "TK Alarm Codes" to help diagnose any alarms. These can be found at the following link: <http://www.europe.thermoking.com/tools/>

**Note:** These are Apps for your Mobile device, please contact your Dealer for desktop applications.

**Figure 15. Premium HMI Control Panel Display**

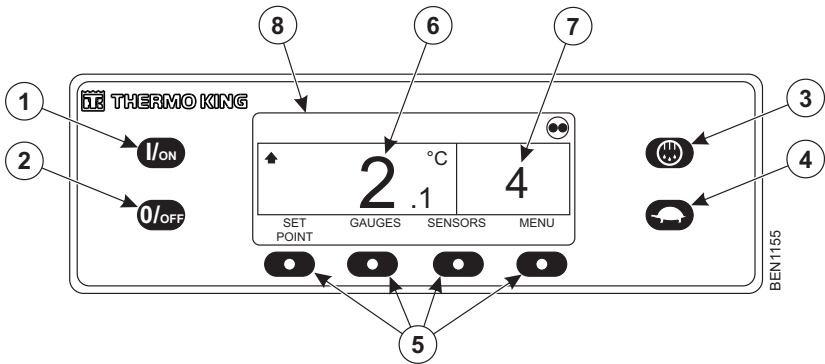

	Hard Keys (1-4)
1.	ON Key
2.	OFF Key
3.	Defrost



**THERMO KING**  
Operating Instructions

4.	High Speed Lockout
5.	Soft Keys
6.	Box Temperature
7.	Setpoint
8.	Display

**Figure 16. SPECTRUM - Premium HMI Control Panel Display**

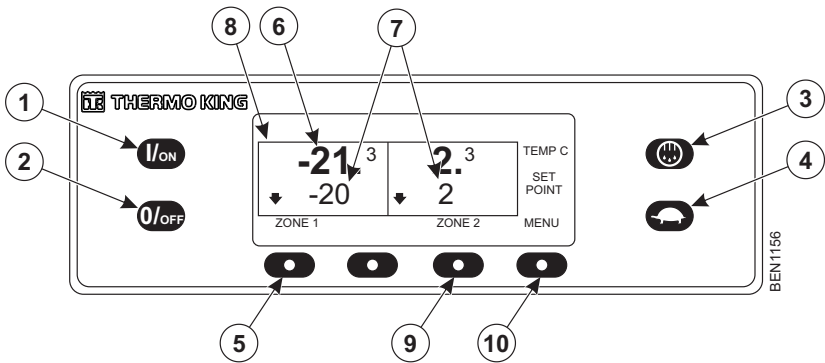

	Hard Keys (1-4)
1.	ON Key
2.	OFF Key
3.	Defrost
4.	High Speed Lockout
5.	Zone 1 Soft Keys
6.	Box Temperature
7.	Setpoint
8.	Zone 2 Display

## Operating Instructions

---

---

9.	Zone 2 Soft Key
10.	Menu Soft Key

The HMI control panel consists of a display and 8 touch-sensitive keys. The display is capable of showing both text and graphics

The keys on the left and right sides of the display are dedicated single function "hard" keys.

The four keys under the display are "soft" keys. The functions of these soft keys change depending on the operation being performed. If a soft key is active the current key function is shown in the display directly above the key.

# Alarm Codes

## Introduction

An alarm code is generated when the microprocessor senses an abnormal condition. Alarms direct an operator or service technician to the source of a problem.

Multiple alarms can be present at one time. All generated alarms will be stored in memory until cleared by the operator. Document all alarm occurrences and report them to the service technician.

**Important:** *Always record any Alarm Codes that occur - in the order that they occur - as well as any other pertinent information. This information is extremely valuable to service personnel.*

### Notes:

1. *Please refer to Profesor Kool and the "TK Tutor Series" App for step by step instructions and training on Alarm types and how to clear alarms. Please refer to "TK Alarm Codes" App for the most up to date alarms list. These apps can be found at the following link: <http://www.europe.thermoking.com/tools/>*
2. *Some alarms (3, 4, 74, 203, and 204) cannot be cleared in the Alarms Menu, they must be cleared in the Maintenance Menu or the Guarded Access Menu. Contact your supervisor or a Thermo King dealer about clearing those alarms.*
3. *In some cases alarms cannot be cleared, or cannot be cleared after they have occurred a specified number of times. If such is the case, these alarms must be cleared by service personnel. These are all explained in your Alarm Codes App.*

# Loading and Enroute Inspections

**Important:** Make sure cargo is pre-cooled to the proper temperature before loading. The Thermo King unit is designed to maintain temperature, not cool an above-temperature load.

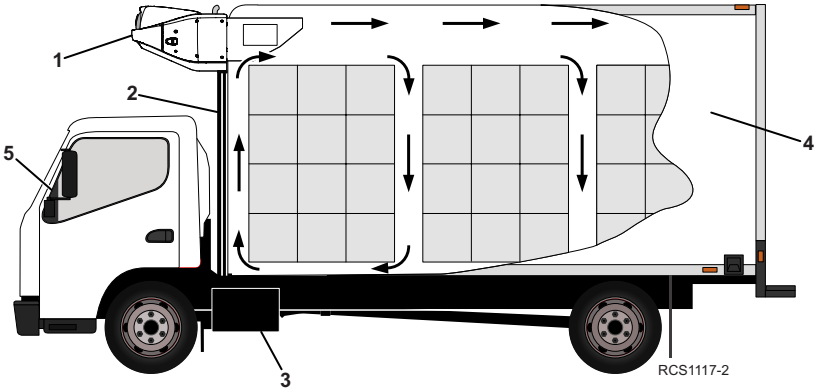

1.	Inspect unit condenser grille openings to ensure they are free of debris.
2.	Inspect unit defrost drain tubes to ensure they are not plugged or kinked.
3.	Confirm there is sufficient fuel in tank to operate unit for time required for deliveries.
4.	Inspect the cargo box compartment inside and out for: <ul style="list-style-type: none"> <li>• Inspect condition of door seals. They must seal tightly with no air leakage.</li> <li>• Damaged walls, missing insulation or blocked floor channels.</li> <li>• Inspect bulkheads (if applicable) for a air tight fit at ceiling, walls, and floor.</li> </ul>
5.	Using the HMI Controller, turn the unit on to pre-cool cargo compartment: <ul style="list-style-type: none"> <li>• Adjust setpoint to desired cargo temperature and allow unit to run a minimum of 30 to 60 minutes (longer if possible) before loading.</li> </ul>
<p><b>Important:</b> As product is being loaded, make sure evaporator air inlets and outlets are not blocked. Maximum air circulation is necessary to properly maintain the temperature of the entire load.</p>	

## Loading and Enroute Inspections

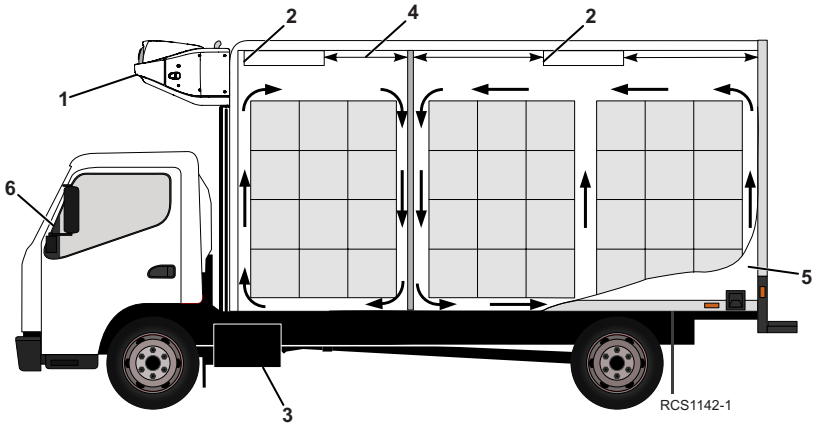

1.	Inspect unit condenser grille openings to ensure they are free of debris.
2.	Inspect evaporator defrost drains to ensure they are not plugged or kinked.
3.	Confirm there is sufficient fuel in tank to operate unit for time required for deliveries.
4.	Maintain a minimum of 1219 mm (48 in.) between evaporator air outlets and wall or bulkhead.
5.	Inspect cargo box compartment inside and out for: <ul style="list-style-type: none"> <li>Inspect condition of door seals. They must seal tightly with no air leakage.</li> <li>Damaged walls, missing insulation or blocked floor channels.</li> <li>Inspect bulkheads (if applicable) for a air tight fit at ceiling, walls, and floor.</li> </ul>
6.	Using the HMI Controller, turn the unit on to pre-cool cargo compartment: <ul style="list-style-type: none"> <li>Adjust setpoint to desired cargo temperature and allow unit to run a minimum of 30 to 60 minutes (longer if possible) before loading cargo.</li> </ul>
<p><b>Important:</b> As product is being loaded, make sure evaporator air inlets and outlets are not blocked. Maximum air circulation is necessary to properly maintain the temperature of the entire load.</p>	

## Inspecting the Load

Never assume that the product has been loaded properly. Watch for and perform the following tasks. It takes only a few minutes and could save you or your employer considerable time and money later on.

## Loading and Enroute Inspections

---

1. Turn the unit off before opening the cargo box doors to maintain efficient operation. Opening the doors while the unit is running allows warm air to enter the cargo box.

**Note:** *The unit can be run with the doors open if the truck is backed into a refrigerated warehouse with tight loading dock door seals.*

2. Perform a final check of the load temperature. If the load is too hot or too cold, make a final notation on the manifest.
3. While inspecting to see that the cargo is loaded properly, make sure the evaporator air inlets and outlets are not blocked.
4. Close or supervise the closing of the cargo compartment doors. Make sure they are securely locked.
5. Check to make sure the unit setpoint is set at the desired temperature as listed on the manifest.
6. If the unit was stopped, restart using the appropriate starting procedure outlined in this manual.
7. Repeat the after-start inspection.
8. Defrost the unit 30 minutes after loading by starting a manual defrost cycle.

## Enroute Inspections

**Note:** *Enroute inspections are recommended every four hours for the prevention of damage to the cargo.*

1. Note the setpoint to make certain no one has altered the setting since picking up the load.
2. Note the return air temperature reading. It should be within the desired temperature range. If the return air temperature reading is not within the desired temperature range, it indicates one of the following:
  - a. The unit has not had sufficient time to pull down the temperature. Refer to log, if possible, for history of load (for example, above temperature load, properly pre-cooled cargo compartment, length of time on road).
  - b. The unit is in defrost or has just completed defrost.

**Note:** *You can cancel defrost by turning the unit off, then restarting the unit.*

- c. The evaporator is plugged with frost. Initiate a manual defrost cycle. The defrost cycle will be automatically terminated.

## Loading and Enroute Inspections

---

- d. Improper air circulation within the cargo compartment. Inspect the cargo compartment (if possible) to determine if the evaporator fans are working and properly circulating the air. Poor air circulation can be due to improper loading of the cargo or shifting of the load, or the fan belt slipping
- e. The unit did not start automatically. If the unit cranked without starting, determine and correct the cause for not starting.
- f. The unit may have a low refrigerant charge. If liquid is not showing in the unit receiver tank sight glass, the refrigerant charge may be low. Adding refrigerant or repairing the refrigeration system requires a competent mechanic. Refer such problems to the nearest Thermo King dealer or authorized Service Center, or call the Thermo King Cold Line telephone number shown on the inside back cover of this manual for referral.

**Note:** *If the temperature in the compartment is not within the desired temperature range, repeat the Enroute Inspection every 30 minutes until the compartment temperature comes within the desired temperature range.*

**Important:** *Stop the unit if the compartment temperature remains outside the desired temperature range from the setpoint on two consecutive 30 minute inspections. Contact the nearest Thermo King Service Center or your company office immediately. Take all necessary steps to protect and maintain proper load temperature.*

3. Initiate a Manual Defrost cycle after each Enroute Inspection.

# Specifications

## Engine

Model:  UT-1200, UT SPECTRUM, UT-800 UT Extreme <sup>HIGH</sup> Ambient	Thermo King TK 376U
Fuel Type	Diesel Fuel must conform to EN 590
Oil Capacity:	Crankcase and Oil Filter: 11.0 litres, w/ Bypass Oil Filter: 12.1 litres. Fill to full mark on dipstick
Oil Type	Petroleum Multi-grade Oil: API Type CI-4, ACEA Class E3 Synthetic Multi-grade Oil (after first oil change): API Type CI-4, ACEA Class E3
Recommended Oil Viscosity (based on ambient temperature)	-10 C to 50 C (14 F to 122 F): SAE 15W-40 (Synthetic) -15 to 40 C (5 to 104 F): SAE 15W-40 -15 to 40 C (5 to 104 F): SAE 10W-30 (Synthetic or Synthetic Blend) -25 to 40 C (-13 to 104 F): SAE 10W-40 -25 to 30 C (-13 to 86 F): SAE 10W-30 -30 to 50 C (-22 to 122 F): SAE 5W-40 (Synthetic) Below -30 C (-22 F): SAE 0W-30 (Synthetic)
Nominal Engine RPM  UT-1200, UT SPECTRUM, UT Extreme <sup>HIGH</sup> Ambient	High Speed 2425 ± 25 RPM Low Speed 1625 ± 25 RPM
UT-800	High Speed 2200 ± 25 RPM Low Speed 1450 ± 25 RPM



Engine Coolant Type	<p>Conventional Coolant: Conventional coolant (antifreeze) is green or blue-green. GM 6038M or equivalent, low silicate antifreeze mixture, 50/50 antifreeze/water mixture, not to exceed 60/40.</p> <p><b>Important:</b> <i>Do not mix conventional coolant and ELC. ELC (Extended Life Coolant): ELC is red. Units containing ELC have an ELC nameplate on the expansion tank. Use a 50/50 concentration of any of the following equivalents: Texaco ELC (7997, 7998, 16445, 16447), Havoline Dex-Cool® (7994, 7995), Havoline XLC for Europe (30379, 33013), Shell Dexcool® (94040), Shell Rotella (94041), Saturn/General Motors Dex-Cool®, Caterpillar ELC, Detroit Diesel POWERCOOL® Plus</i></p>
<p style="text-align: center;"><b>NOTICE</b></p> <p><b>System Contamination!</b></p> <p>Do not add "GREEN" or "BLUE-GREEN" conventional coolant to cooling systems using "RED" Extended Life Coolant, except in an emergency. If conventional coolant is added to Extended Life Coolant, the coolant must be changed after 2 years instead of 5 years.</p>	
<p style="text-align: center;"><b>NOTICE</b></p> <p><b>Equipment Damage!</b></p> <p>Do not use high silicate automobile antifreeze.</p>	
Coolant System Capacity	Check the coolant level in the overflow bottle. It should be above the Full Cold line. If necessary, add coolant to the overflow bottle.
Coolant Expansion Tank Cap Pressure	UT-Series : 7 psig (48 Kpa)

## Fuses

Fuse	Size	Function
F2	15A	Power to ON/OFF Switch
F3A	40A	Fuel Solenoid Pull-In/ Starter Circuit

## Specifications

F4	none 2A	No Fuse - All Bosch and Thermo King Alternators 2A Fuse - All Prestolite Alternators
F5	40A	Preheat Circuit
F6	15A	High Speed Circuits
F7	2A	8XP Circuit - Controller On Feedback to HMI
F8	5A	2A Power to CAN Connector J12
F9	5A	2A Power to CAN Connector J14
F10	10A	8X Power (Install fuse in upper position)
F11	10A	Zone 1 LLS
F12	5A	CAN Connector J13
F13	2A	8FC Circuit (Remote Lights)
F20	2A	Alternator Sense
F21	60A	Main Fuse (2 Circuit)
F25	7.5A	HPCO/Run Circuit
F4 Depending on your unit, this fuse maybe removed, please consult your Dealer for further information.		
F10 When fuse F10 is installed in the upper position the On/Off keys on the HMI turn the unit on and off. When fuse F10 is installed in the lower position the unit will start and run without the HMI control panel.		

## Electrical Control System

Low Voltage	12.5 Vdc (nominal)
Voltage Regulator Setting	13.95 to 14.4 volts @ 77 F (25 C)
Fuses	12 Volt, AHr Rating - 75 AHrs, 640 Cold Cranking Amps at -18C (ENCCA)
Battery Charging	120 amp, (Brush Type) Integral Alternator used with UT-1200, UT SPECTRUM. 65 amp, (Brush Type) Integral Alternator used with UT-800

---

## Standby Power Requirements

Supply Circuit Breaker:  200-230/3/50-60 (UT-Series unit) All 380-46/3/50-60 (UT-Series unit)	50 amps 20 Amps
Extension Cord Size:	Up to 15 m — 10 gauge 23 m — 8 gauge

# Warranty

Terms of the Thermo King Self Powered Truck Unit Warranty are available on request from your Thermo King Dealer.

Also refer to TK 61598-2-WA Thermo King EMEA Limited Warranty for Self Powered Truck Units.

# Maintenance Inspection Schedule

## Inspection and Service Intervals

Inspection and Service intervals are determined by the number of unit operating hours and by the age of the unit. Examples are shown in the table below. Your Dealer will prepare a schedule to suit your specific needs.

**Service Record:** Each inspection and service performed should be recorded on your Dealer Service Record.

<b>Interim Inspection</b>	<b>Complete PM</b>
A Service Every 1000 hours or every 6 months (whichever comes first)	B Service Every 2000 hours or every 24 months (whichever comes first)

<b>Pretrip</b>	<b>Inspect/Service These Items</b>
•	Run Pretrip Test (Refer to "TSR-3 Controller," p. 30).
•	Check fuel supply.
•	Check and adjust coolant/engine oil levels.
•	Listen for unusual noises, vibrations, etc.
•	Visually inspect unit for fluid leaks. (fuel, coolant, oil and refrigerant).
•	Visually inspect unit for damaged, loose or broken parts (includes air ducts and bulkheads if so equipped).
<p><b>Note:</b> For further best practices, please go to <a href="http://www.europe.thermoking.com/best-practices">www.europe.thermoking.com/best-practices</a>.</p>	

# Serial Number Locations

**Figure 17. Serial Number Location**

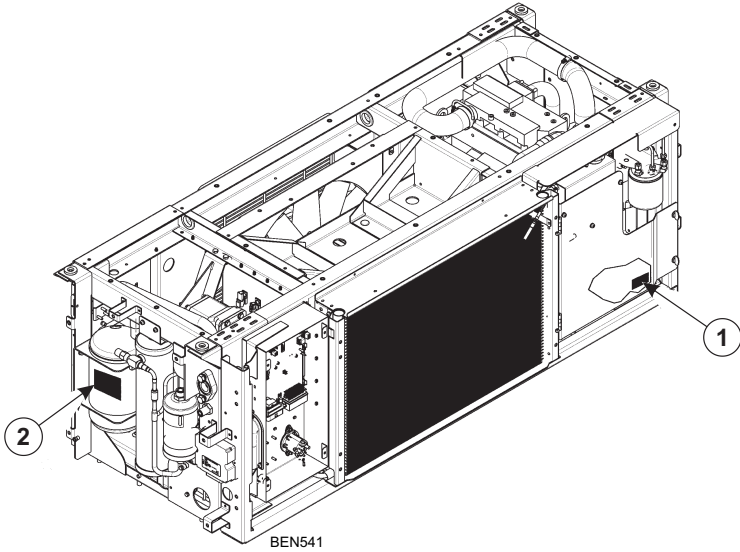

**Figure 18. Serial Number Plates**

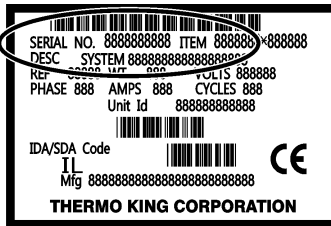

ARA901

**Figure 19. Serial Number Plate Location  
(S-3 shown, S-2 similar)**



- |    |  |
|----|--|
| 1. | Serial nameplate on right end of evaporator frame behind cover |
|----|--|

## Recover Refrigerant

At Thermo King®, and FrigoBlock we recognize the need to preserve the environment and limit the potential harm to the ozone layer that can result from allowing refrigerant to escape into the atmosphere.

We strictly adhere to a policy that promotes the recovery and limits the loss of refrigerant into the atmosphere.

In addition, service personnel must be aware of Federal regulations concerning the use of refrigerants and the certification of technicians. For additional information on regulations and technician certification programs, contact your local THERMO KING dealer.









Thermo King – by Trane Technologies (NYSE: TT), a global climate innovator – is a worldwide leader in sustainable transport temperature control solutions. Thermo King has been providing transport temperature control solutions for a variety of applications, including trailers, truck bodies, buses, air, shipboard containers and railway cars since 1938. For more information, visit [www.thermoking.com](http://www.thermoking.com) or [www.tranetechnologies.com](http://www.tranetechnologies.com).

Thermo King has a policy of continuous product and product data improvements and reserves the right to change design and specifications without notice. We are committed to using environmentally conscious print practices.